

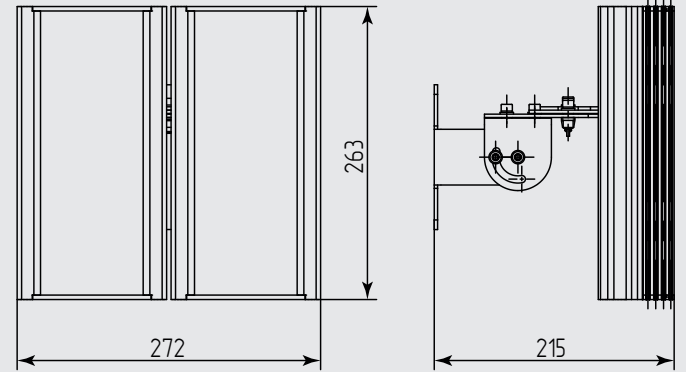

Helios IR-294-XXL x2

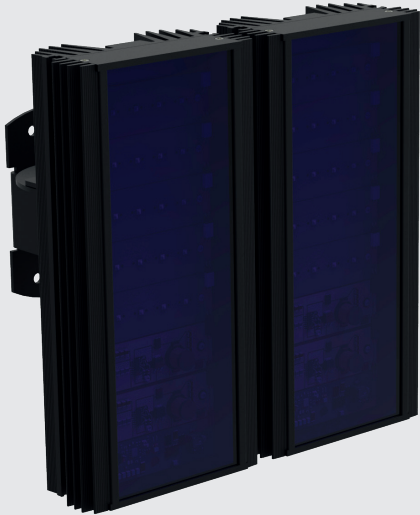







Infrared Illuminator with adjustable angle

MICROLIGHT



Supply voltage	185...265 B AC
Power consumption	90.0 W
Built-in photocell	yes
Ingress protection	IP67, IK10
Operation temperature	-40...+50 °C
Weight	5.8 kg

Wavelength, nm	Angle, ° (min - max)	Distance, m (max - min)	Horizontal spot size, m (min - max)
850	10 - 20	435 - 310	76 - 108
	15 - 30	283 - 200	74 - 104
	30 - 60	145 - 105	77 - 105
	45 - 90	100 - 72	78 - 102
	60 - 110	72 - 51	72 - 84
	90 - 140	51 - 36	72
	120 - 170	38 - 27	66
940	10 - 20	205 - 145	35 - 50
	15 - 30	120 - 85	31 - 44
	30 - 60	69 - 49	36 - 49
	45 - 90	44 - 31	34 - 44
	60 - 110	35 - 25	35 - 41
	90 - 140	25 - 18	35
	120 - 170	17 - 12	29

-  high-performance surface-mount LEDs
-  increased efficiency of removal of heat from the radiating elements
-  IR light filter with minimal loss of radiation power
-  built-in current regulator
-  tripping delay photocell to prevent accidental turn off
-  built-in photocell
-  supply voltage 185...265 V AC
-  supply voltage 12...24 V AC/DC

Optional:
w/o built-in photocell
supply voltage 12...24 V AC/DC
RAL color available

